

FIELD NOTCH DECK
AROUND BEAM PLATE

FASTEN BEAM TO CORNICE MOLD
W/ #10-16x1 1/2" TEK 3 SCREWS

3/4" BEAM PLATE

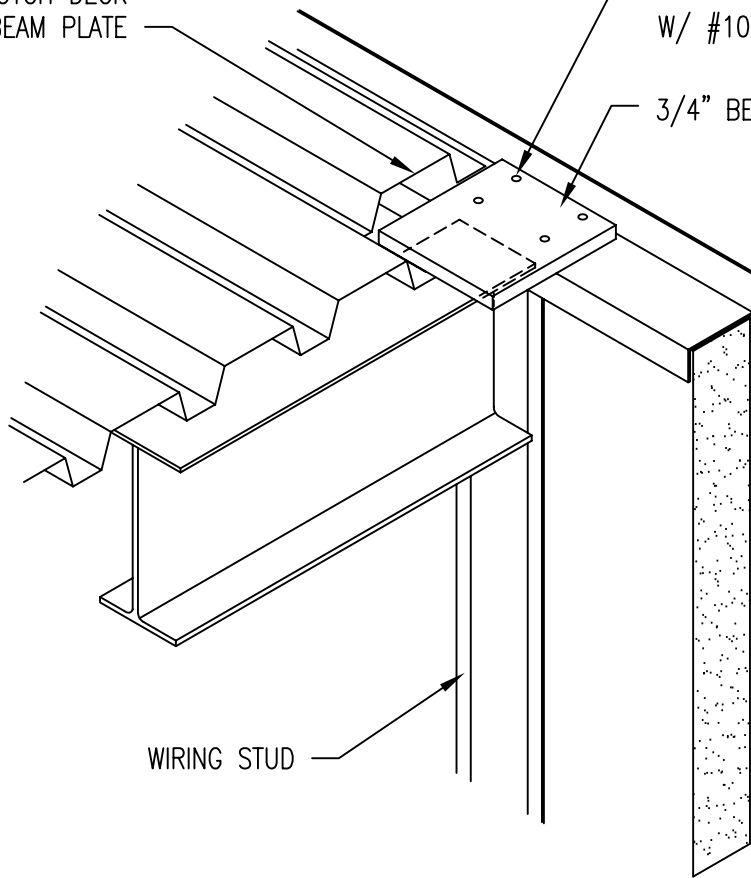

WIRING STUD

RECESSED BEAM CONNECTION

PORTA-FAB
CORPORATION

P.O. BOX 1084 CHESTERFIELD, MO. 63006-1084

JOB: 18w8

SCALE

NTS

DATE

These documents were developed by PORTA-FAB Corporation. The contents of these documents are the property of PORTA-FAB corporation. They are not to be copied or otherwise used without the express written permission of PORTA-FAB Corporation.

DRAWN BY

SWC

REVISED

CHECKED

SHEET NO. 1 OF 1